



## CSIR UGC NET PHYSICAL SCIENCE – MOCK TEST PAPER

## CSIR UGC NET PHYSICAL SCIENCE – MOCK TEST PAPER

- This paper contains 55 Multiple Choice Questions
- Part A 15, part B 20 and part C 20
- Each question in Part 'A' carries two marks
- Part 'B' carries 3.5 marks
- Part 'C' carries 5 marks respectively
- There will be negative marking @ 25% for each wrong answer.
- Pattern of questions : MCQs
- Total marks : 200
- Duration of test : 3 Hours

## PART-A (Q.1-15)

1. Identify the next figure in the sequence

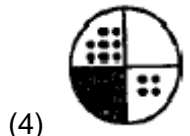
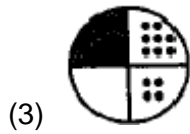
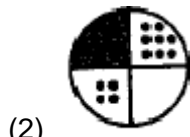
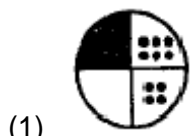
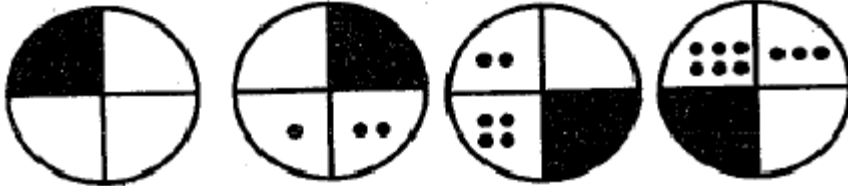

2. A daily sheet calendar of the year 2013 contains sheets of  $10 \times 10$  cm size. All the sheets of the calendar are spread over the floor of a room of  $5\text{m} \times 7.3\text{m}$  size. What percentage of the floor will be covered by these sheets?

(1) 0.1

(2) 1

(3) 10

(4) 100

3. A car is moving along a straight track. Its speed is changing with time as shown.

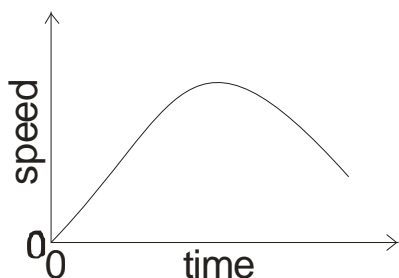

Which of the following statements is correct?

- (1) The speed is never zero.
  - (2) The acceleration is zero once on the path.
  - (3) The distance covered initially increases and then decreases.
  - (4) The car comes back to its initial position once.
4. There are 2 hills, A and B, in a region. If hill A is located  $N30^\circ E$  of hill B, what will be the direction of hill B when observed from hill A? ( $N 30^\circ E$  means  $30^\circ$  from north towards east).
- (1)  $S 30^\circ W$
  - (2)  $S 60^\circ W$
  - (3)  $S 30^\circ E$
  - (4)  $S 60^\circ E$
5. Average yield of a product in different years is shown in the histogram. If the vertical bars indicate variability during the year, then during which year was the percent variability over the average of that year the least?

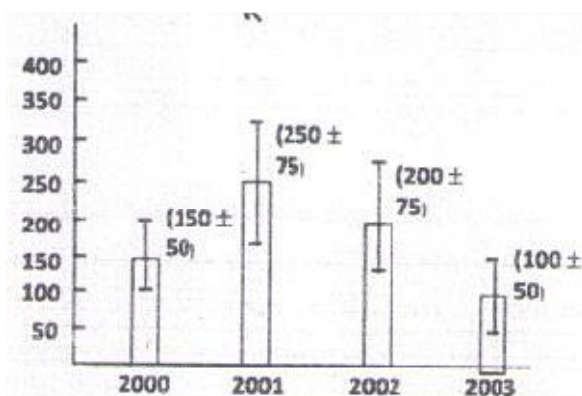

- (1) 2000
- (2) 2001

- (3) 2002  
(4) 2003
6. 20% of students of a particular course get jobs within one year of passing. 20% of the remaining students get jobs by the end of second year of passing. If 16 students are still jobless, how many students had passed the course?
- (1) 32  
(2) 64  
(3) 25  
(4) 100
7. A sphere of iron of radius  $R/2$  fixed to one end of a string was lowered into water in a cylindrical container of base radius  $R$  to keep exactly half the sphere dipped. The rise in the level of water in the container will be

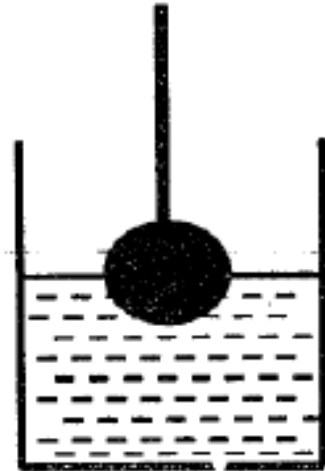

- (1)  $R/3$   
(2)  $R/4$   
(3)  $R/8$   
(4)  $R/12$
8. Three identical flat equilateral-triangular plates of side 5 cm each are placed together such that they form a trapezium. The length of the longer of the two parallel sides of this trapezium is

- (1)  $5\sqrt{\frac{3}{4}}$  cm  
 (2)  $5\sqrt{2}$  cm  
 (3) 10 cm  
 (4)  $10\sqrt{3}$  cm

9. Consider a right-angled triangle ABC where  $AB = AC = 3$ . A rectangle APOQ is drawn inside it, as shown such that the height of the rectangle is twice its width. The rectangle is moved horizontally by a distance 0.2 as shown schematically in the diagram (not to scale).

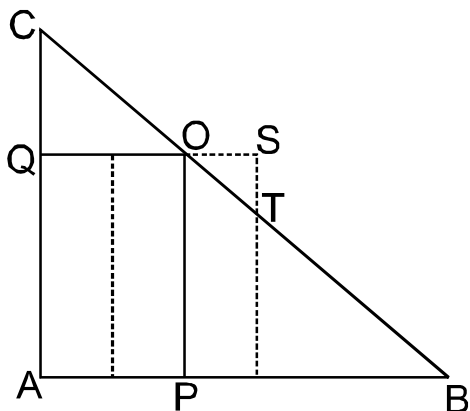

$$\frac{\text{Area of } \triangle ABC}{\text{Area of } \triangle OST} ?$$

What is the value of the ratio

- (1) 625  
 (2) 400  
 (3) 225  
 (4) 125
10. A code consists of at most two identical letters followed by at most four identical digits. The code must have at least one letter and one digit. How many distinct codes can be generated using letters A to Z and digits 1 to 9?
- (1) 936  
 (2) 1148  
 (3) 1872

(4) 2574

11. Find the missing letter :

A	?	Q	E
C	M	S	C
E	K	U	A
G	I	W	Y

- (1) L
- (2) Q
- (3) N
- (4) O

12. If  $3 \leq X \leq 5$  and  $8 \leq Y \leq 11$  then which of the following options is TRUE?

(1)  $\frac{3}{5} \leq \frac{X}{Y} \leq \frac{8}{5}$

(2)  $\frac{3}{11} \leq \frac{X}{Y} \leq \frac{5}{8}$

(3)  $\frac{3}{11} \leq \frac{X}{Y} \leq \frac{8}{5}$

(4)  $\frac{3}{5} \leq \frac{X}{Y} \leq \frac{8}{11}$

13. If  $y = 5x^2 + 3$ , then the tangent at  $x = 0, y = 3$ .

- (1) passes through  $x = 0, y = 0$
- (2) has a slope of +1
- (3) is parallel to the x-axis
- (4) has a slope of -1

14. A student buys a book from an online shop at 20% discount. His friend buys another copy of the same book in a book fair for Rs. 192 paying 20% less than his friend. What is the full price of the book?

- (1) Rs. 275
- (2) Rs. 300
- (3) Rs. 320
- (4) Rs. 392

15. A square pyramid is to be made using a wire such that only one strand of wire is used for each edge. What is the minimum number of times that the wire has to be cut in order to make the pyramid?

- (1) 3
- (2) 7
- (3) 2
- (4) 1

## PART-B (Q. 16 TO 35)

$$\oint_C \frac{e^z \sin(z)}{z^2} dz$$

16. The value of the integral  $\oint_C \frac{e^z \sin(z)}{z^2} dz$ , where the counter C is the unit circle

$|z - 2| = 1$ , is

- (1)  $2\pi i$
- (2)  $4\pi i$
- (3)  $\pi i$
- (4) 0

17. If  $f(x) = \begin{cases} 0 & \text{for } x < 3 \\ x - 3 & \text{for } x \geq 3 \end{cases}$  then the Laplace transform of  $f(x)$  is

- (1)  $S^{-2} e^{Sx}$
- (2)  $S^2 e^{Sx}$
- (3)  $S^{-2}$
- (4)  $S^{-2} e^{-Sx}$



18. The solution of the differential equation for  $y(t)$   $\frac{d^2y}{dt^2} - y = 2 \cosh(t)$ , subject to the initial conditions

$$y(0) = 0 \text{ and } \left. \frac{dy}{dt} \right|_{t=0} = 0, \text{ is}$$

- (1)  $\frac{1}{2} \cosh(t) + t \sinh(t)$   
 (2)  $t \cosh(t)$   
 (3)  $-\sinh(t) + t \cosh(t)$   
 (4)  $t \sinh(t)$
19. The acceleration due to gravity ( $g$ ) on the surface of earth is approximately 2.3 times that on the surface of mars. Given that the radius of mass is about three - fourth the radius of earth the ratio of the escape velocity on earth on that mass approximately

- (1) 1.1  
 (2) 1.3  
 (3) 2.3  
 (4) 2.6

20. Consider the decay process  $\tau^- \rightarrow \pi^- + \nu$  in the rest frame of the  $\tau^-$ . The masses of the  $\tau^-$ ,  $\pi^-$  and  $\nu$  are  $M_\tau$ ,  $M_\pi$  and zero respectively. The energy of  $\pi^-$  is.

(1)  $\frac{(M_\tau^2 - M_\pi^2)}{2M_\tau} c^2$

(2)  $\frac{(M_\tau^2 + M_\pi^2)}{2M_\tau} c^2$

(3)  $(M_\tau - M_\pi) c^2$

(4)  $\sqrt{M_\tau M_\pi} c^2$

21. The Hamiltonian of a particle of unit mass moving in the xy plane is given to be

$H = xP_x - yP_y - \frac{1}{2}x^2 + \frac{1}{2}y^2$  in suitable units, The initial values are given to be  $(x(0), y(0)) = (1, 1)$  and

$(P_x(0), P_y(0)) = \left(\frac{1}{2}, -\frac{1}{2}\right)$  During the motion, the curved traced out by the particles in the  $xy$  - plane and the  $P_xP_y$  - plane are

- (1) Both straight lines
- (2) A straight line and a hyperbola respectively.
- (3) A hyperbola and an ellipse, respectively
- (4) Both hyperbolas.

22. A square loop of Area  $A$  lie in  $x - y$  plane. An electromagnetic wave is  $\vec{E} = \vec{E}_0 \cos(\vec{k} \cdot \vec{r} - \omega t)$  propagating in space. The power crossing through the square is-

(1)  $\frac{E_0^2}{2\mu_0 c} \vec{A} \cdot \vec{K}$

(2)  $\frac{E_0^2}{\mu_0 c} \vec{A} \cdot \vec{K}$

(3)  $\frac{2E_0^2}{\mu_0 c} \vec{A} \cdot \vec{K}$

(4)  $\frac{E_0^2}{4\mu_0 c} \vec{A} \cdot \vec{K}$

23. The electric field  $E(r,t)$  at a point  $r$  at time  $t$  in a metal due to the passage of electrons can be described by the equation

$$\nabla^2 \mathbf{E}(\mathbf{r}, t) = \frac{1}{c^2} \left[ \frac{\partial^2 \mathbf{E}(\mathbf{r}, t)}{\partial t^2} + \omega'^2 \vec{\mathbf{E}}(\mathbf{r}, t) \right]$$

Where  $\omega'$  is a characteristic associated with the metal and  $c$  is the speed of light in vacuum The dispersion

relation corresponding to the plane wave solution of the form  $\text{Exp} \left[ i(\vec{\mathbf{i}} \cdot \vec{\mathbf{r}} - \omega t) \right]$  is given by

(1)  $\omega^2 = c^2 k^2 - \omega'^2$

(2)  $\omega^2 = c^2 k^2 + \omega'^2$

(3)  $\omega = ck + \omega'$

(4)  $\omega = ck - \omega'$

24. Consider an electric dipole of mass  $m$  and magnitude of charge is  $q$ , equivalent to an accelerated charge radiating power. The dipole moment amplitude  $p_0$  in term of charge ( $q$ ) and acceleration  $\vec{\mathbf{a}}$  of accelerated charge is

(1)  $\frac{q\omega^2}{\vec{\mathbf{a}}}$

(2)  $\frac{q\vec{\mathbf{a}}}{\omega^2}$

(3)  $\frac{q^2}{\omega^3} \vec{\mathbf{a}}$

(4) None of these

25. The normalized wave functions  $\Psi_1$  and  $\Psi_2$  correspond to the ground state and the first excited state of a particle in a potential. An operator  $\hat{\mathbf{A}}$  acts on the wave function as  $\hat{\mathbf{A}}\Psi_1 = \Psi_2$  and  $\hat{\mathbf{A}}\Psi_2 = \Psi_1$ . The

$$\Psi = \frac{1}{5}(3\Psi_1 + 4\Psi_2)$$

expectation value of  $A$  for the .

(1) -0.32

(2) 0

(3) 0.75

(4) 0.96

26. A particle is described by the wave function  $\psi(x) = \frac{1+ix}{1+ix^2}$ . The particle is most likely to found at

(1)  $\pm\sqrt{\sqrt{3}-1}$

(2)  $\pm\sqrt{\sqrt{3}+1}$

(3)  $\pm\sqrt{\sqrt{2}-1}$

(4)  $\pm\sqrt{\sqrt{2}+1}$

27. If the perturbation  $H' = ax$ , where  $a$  is a constant, is added to infinite square well potential  $v(x) =$
- $$\begin{cases} 0 & \text{for } 0 \leq x \leq \pi \\ \infty & \text{otherwise} \end{cases}$$

The correction to the ground state energy to first order is a is

(1)  $\frac{a\pi}{2}$

(2)  $a\pi$

(3)  $\frac{a\pi}{4}$

(4)  $\frac{a\pi}{\sqrt{2}}$

28. An ideal gas of non - relativistic fermions in 3 - dimension is at 0K. When both the number density and mass of the particles are doubled, then the energy per particle is multiplied by a factor

(1)  $2^{1/2}$

(2) 1

(3)  $2^{1/3}$

(4)  $2^{-1/3}$

29. A monoatomic gas consists of atoms with two internal energy, ground state  $E_0 = 0$  and an excited state  $E_1 = E$ . The specific heat of the gas is given by

(1)  $\frac{3}{2}K$

(2)  $\frac{E^2 e^{E/Kt}}{KT^2 (1 + e^{E/Kt})^2}$

(3)  $\frac{3}{2}K + \frac{E^2 e^{E/KT}}{KT^2 (1 + e^{E/KT})^2}$

(4)  $\frac{3}{2}K - \frac{E^2 e^{E/KT}}{KT^2 (1 + e^{E/KT})^2}$

30. A uniform surface current is flowing in the positive y-direction over an infinite sheet lying in x-y plane. The direction of the magnetic field is

(1) along  $\hat{i}$  for  $z > 0$  and along  $-\hat{i}$  for  $z < 0$

(2) along  $\hat{k}$  for  $z > 0$  along  $-\hat{k}$  for  $z < 0$

(3) along  $-\hat{i}$  for  $z > 0$  and along  $\hat{i}$  for  $z < 0$

(4) along  $-\hat{k}$  for  $z > 0$  along  $\hat{k}$  for  $z < 0$

31. A simple cubic crystal with lattice parameter  $a$ , undergoes transition into a tetragonal structure with lattice parameters  $a_t = b_t = \sqrt{2} a_c$  and  $c_t = 2a$  below a certain temperature. The ratio of the interplanar spacings of (1 0 1) planes for the-cubic and the tetragonal structures is

(1)  $\sqrt{\frac{1}{6}}$

(2)  $\frac{1}{6}$

(3)  $\sqrt{\frac{3}{8}}$

(4)  $\frac{3}{8}$

32. The pressure of a nonrelativistic free fermi gas in three-dimensions depends, at  $T = 0$ , on the density of fermions  $n$  as

(1)  $n^{5/3}$

(2)  $n^{1/3}$

(3)  $n^{2/3}$

(4)  $n^{4/3}$

33. The dc current gain ( $\beta$ ) of a BJT is 50. Assuming that The emitter injection efficiency is 0.995, the base transport factor is :-

(1) 0.980

(2) 0.990

(3) 0.985

(4) 0.995

34. A particle of mass  $m$  moves inside a bowl. If the surface of the bowl is given by the equation  $ax^2 + ay^2 - 2z = 0$ , where  $a$  is constant, the langragian of the particle is

(1)  $\frac{1}{2}m(\dot{r}^2 + r^2\dot{\phi}^2 - gar^2)$

(2)  $\frac{1}{2}m[(1+a^2r^2)\dot{r}^2 + r^2\dot{\phi}^2]$

$$(3) \frac{1}{2} m \left[ (1 + a^2 r^2) \dot{r}^2 + r^2 \dot{\phi}^2 - g a r^2 \right]$$

$$(4) \frac{1}{2} m \left[ \dot{r}^2 + r^2 \dot{\phi}^2 + r^2 \sin^2 \theta \dot{\phi}^2 - g a r^2 \right]$$

35. A lattice has the following primitive vectors (in Å) :

$$\vec{a} = 2(\hat{j} + \hat{k}), \vec{b} = 2(\hat{k} + \hat{i}), \vec{c} = 2(\hat{i} + \hat{j}).$$

The reciprocal lattice corresponding to the above lattice is

$$(1) \text{ BCC lattice with cube edge of } \left( \frac{\pi}{2} \right) \text{Å}^{-1}$$

$$(2) \text{ BCC lattice with cube edge of } (2\pi) \text{Å}^{-1}$$

$$(3) \text{ FCC lattice with cube edge of } \left( \frac{\pi}{2} \right) \text{Å}^{-1}$$

$$(4) \text{ FCC lattice with cube edge of } (2\pi) \text{Å}^{-1}$$

36. A computer system has a 4K work cache organised in blockset associative manner with 4 blocks per set, 64 words per block. The no. of bits in the set & WORD fields of the main memory address formula is :-

$$(1) 16,4$$

$$(2) 6,4$$

$$(3) 7,2$$

$$(4) 4,6$$

37. X-Ray of wavelength  $\lambda = a$  is reflected from the (111) plane of a simple cubic lattice. If the lattice constant is a, the corresponding Bragg angle (in radian) is

$$(1) \frac{\pi}{6}$$

$$(2) \frac{\pi}{4}$$

$$(3) \frac{\pi}{3}$$

$$(4) \frac{\pi}{8}$$

38. The critical magnetic fields of a super conductor at temperatures 4K and 8K are 11mA/m and 5.5mA/m respectively. The Transition temperature is approximately -

- (1) 8.4k
- (2) 10.6k
- (3) 12.9k
- (4) 15.0k

39. The dispersion relation of phonons in a solid is given by

$$\omega^2(\mathbf{k}) = \omega_0^2 (3 - \cos k_x a - \cos k_y a - \cos k_z a)$$

The velocity of the phonons at large wavelength is

$$(1) \frac{\omega_0 a}{\sqrt{3}}$$

$$(2) \omega_0 a$$

$$(3) \sqrt{3} \omega_0 a$$

$$(4) \omega_0 a / \sqrt{2}$$

40. A thermodynamic system is maintained at constant temperature and pressure. In thermodynamic equilibrium, its

- (1) Gibbs free energy is minimum
- (2) enthalpy is maximum
- (3) Helmholtz free energy is minimum.
- (4) Internal energy is zero.

## PART-C (Q. 41-60)



41. Consider a system of  $N$  non-interacting distinguishable spin  $\frac{-1}{2}$  particles each of magnetic moment  $\mu$ . The system is at an equilibrium temperature  $T$  in a magnetic field  $B$  such that  $n$  particles have their magnetic moments aligned parallel to  $B$ . Then the ratio  $\frac{n}{N}$  is \_\_\_\_\_.

(1) 1

(2) 2

(3)  $\frac{1}{e^{-2\mu B/KT} + 1}$

(4)  $\frac{1}{e^{-2\mu B/KT} - 1}$

42. For a system of two bosons each of which can occupy any of the two energy levels 0 and  $\epsilon$  the mean

energy of the system at temperature  $T$  with  $\beta = \frac{1}{K_B T}$  is given by

(1)  $\frac{\epsilon e^{-\beta\epsilon} + 2\epsilon e^{-2\beta\epsilon}}{1 + 2e^{-\beta\epsilon} + e^{-2\beta\epsilon}}$

(2)  $\frac{1 + \epsilon e^{-\beta\epsilon}}{2e^{-\beta\epsilon} + e^{-2\beta\epsilon}}$

(3)  $\frac{2\epsilon e^{-\beta\epsilon} + \epsilon e^{-2\beta\epsilon}}{1 + e^{-\beta\epsilon} + e^{-2\beta\epsilon}}$

(4)  $\frac{\epsilon e^{-\beta\epsilon} + 2\epsilon e^{-2\beta\epsilon}}{1 + e^{-\beta\epsilon} + e^{-2\beta\epsilon}}$

43. Using Cauchy's integral formula, evaluate  $\int_c \frac{zdz}{(9-z^2)(z+i)}$ , where  $c$  is the circle  $|z| = 2$  described in the counter-clockwise sense.

(1) 0

(2)  $\frac{\pi}{5}$

(3)  $4\pi i$

(4)  $2\pi i$

44. The Taylor expansion of the function  $\ln(\cosh x)$ , where  $x$  is real, about the point  $x = 0$  starts with the following terms

(1)  $-\frac{1}{2}x^2 + \frac{1}{12}x^4 + \dots$

(2)  $\frac{1}{2}x^2 - \frac{1}{12}x^4 + \dots$

(3)  $-\frac{1}{2}x^2 + \frac{1}{6}x^4 + \dots$

(4)  $\frac{1}{2}x^2 + \frac{1}{6}x^4 + \dots$

45. Given a  $2 \times 2$  unitary matrix  $U$  satisfying  $U+U = U U+ = 1$  with  $\det U = e^{iQ}$ , one can construct a unitary  $V (V + V = V V+ = 1)$  matrix with  $\det V = 1$  from it by

(1) multiplying  $U$  by  $e^{-i\phi/2}$

(2) multiplying  $U$  by  $e^{-i\phi}$

(3) multiplying any single element of  $U$  by  $e^{-i\phi}$

(4) multiplying any row or column of  $U$  by  $e^{-i\phi/2}$

46. A constant force  $F$  is applied to a relativistic particle of rest mass  $m$ . If the particle starts from rest at  $t = 0$ , its speed after a time  $t$  is.

(1)  $\frac{Ft}{m}$

(2)  $c \tanh \left( \frac{Ft}{mc} \right)$

(3)  $c(1 - e^{-Ft/mc})$

(4)  $\frac{Fct}{\sqrt{F^2t^2 + m^2c^2}}$

47. The potential of a diatomic molecule as a function of distance  $r$  between the atoms is given by  $v(r) =$

$\frac{P}{r^{12}} - \frac{q}{r^6}$ . The value of potential at equilibrium separation between the atoms is

(1)  $\frac{-q^2}{4p}$

(2)  $\frac{-q^2}{2p}$

(3)  $\frac{-2p^2}{q}$

(4)  $\frac{-4p^2}{q}$

48. Two particles of identical mass move in circular orbit under a central potential  $v(r) = \frac{1}{2}kr^2$ . Let  $\ell_1$  and

$\ell_2$  be the angular momenta and  $r_1$  and  $r_2$  be the radii of the orbits respectively  $\frac{\ell_2}{\ell_1} = 4$ . The value of  $r_1/r_2$  is

(1)  $\sqrt{2}$

(2)  $\frac{1}{\sqrt{2}}$

(3) 2

(4)  $\frac{1}{2}$

49. The degree of polarization for ordinary light reflected from glass at an incident angle  $45^\circ$  is

(1) 83.3%

(2) 6.7%

(3) 28.1%

(4) 60%

50. Two infinite long grounded metal plates, again at  $y=0$  and  $y=a$ , are connected at  $x = \pm b$  by metal strips maintained at a constant potential  $V_0$ , as a thin layer of insulation at each corner prevents them from shorting out. The potential inside the resulting rectangular pipe is

(1) 
$$v(x, y) = \frac{uV_0}{\pi} \sum_{n=1,3,5} \frac{1}{n} \frac{\cosh(n\pi x/a)}{\cosh(n\pi b/a)} \sin(n\pi y/a)$$

(2) 
$$v(x, y) = \frac{V_0}{\pi} \sum_{n=1,3,5} \frac{1}{n} \frac{\cosh(n\pi x/a)}{\cosh(n\pi b/a)} \sin(n\pi y/a)$$

(3) 
$$v(x, y) = \frac{uV_0}{\pi} \sum_{n=1,2,3} \frac{1}{n} \frac{\cosh\left(\frac{n\pi x}{a}\right)}{\cosh(n\pi b/a)} \sin\left(\frac{n\pi y}{a}\right)$$

(4)  $V(x, y) = 0$

51. The electric field produced by a uniformly polarized sphere of radius R.

(1)  $\frac{K\theta}{R^2}$

(2)  $\frac{3K\theta}{5R^2}$

(3)  $\frac{-P}{3\epsilon_0}$

(4)  $\frac{-3P}{5\epsilon_0}$

52. Effective Hamiltonian for a system of two spin  $\frac{1}{2}$  particles is given as

$$H = \alpha(S_{1z} + S_{2z}) + \beta \vec{S}_1 \cdot \vec{S}_2$$

Where  $S_1$  and  $S_2$  are the two spins and  $S_{1z}$  and  $S_{2z}$  are their z - components. The maximum gap between and singlet level is

(1)  $\alpha$

(2)  $\beta$

(3)  $\alpha + \beta$

(4)  $\alpha - \beta$

53. Let  $\vec{L} = (L_x, L_y, L_z)$  denote the orbital angular momentum operators of a particle and let  $L_+ = L_x + iL_y$  and  $L_- = L_x - iL_y$ . The particle is in an eigen state of  $L^2$  and  $L_z$  eigen value  $\hbar^2 (\ell + 1)$  and  $\hbar\ell$  respectively. The expectation value of  $L_+ L_-$  in this state is

(1)  $\ell\hbar^2$

(2)  $2\ell\hbar^2$

(3) 0

(4)  $\ell\hbar$

54. Given the Hamiltonian operator for a two state system

$(H = a|1\rangle\langle 1| - |2\rangle\langle 2| + |1\rangle\langle 2| + |2\rangle\langle 1|)$  The energy eigenvalues is/are \_\_\_\_\_.

(1)  $\perp$

(2)  $-\perp$

(3)  $\pm 2$

(4)  $\pm\sqrt{2}$

55. A sphere of homogeneous linear dielectric material is placed in an otherwise uniform electric field  $E_0$ , then the electric field inside the sphere

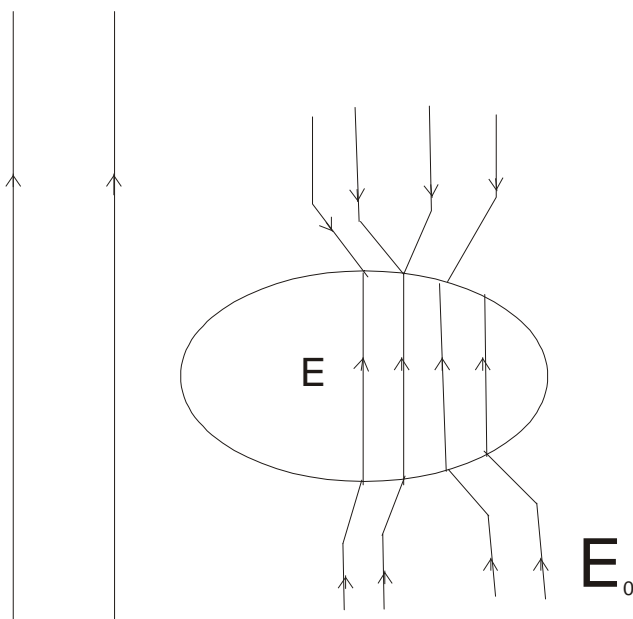

(1) 
$$E = \frac{3}{\epsilon_r + 2} E_0$$

(2) 
$$E = \frac{3}{\epsilon_r} E_0$$

$$(3) \quad E = \frac{2}{\epsilon_r + 3} E_0$$

$$(4) \quad E = \frac{2}{\epsilon_r} E_0$$

## ANSWER KEY

Ques	1	2	3	4	5	6	7	8	9	10
Ans	3	1	2	3	2	3	4	3	3	3
Ques	11	12	13	14	15	16	17	18	19	20
Ans	4	2	3	2	3	4	4	4	2	2
Ques	21	22	23	24	25	26	27	28	29	30
Ans	4	1	1	2	4	3	1	4	3	4
Ques	31	32	33	34	35	36	37	38	39	40
Ans	3	1	3	3	1	4	3	2	4	1
Ques	41	42	43	44	45	46	47	48	49	50
Ans	3	4	2	2	1	4	1	4	1	1
Ques	51	52	53	54	55					
Ans	3	3	1	4	1					

## HINTS AND SOLUTIONS :

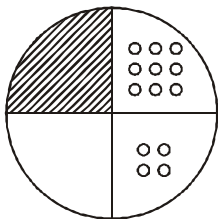

1.(3)

on analysis we get this easily.

2.(1) A daily calendar shut size = 10 × 10 c.m.

Two sides printed month calendar have six sheets. So

Total area can be covered is =  $6 \times 10 \times 10 \text{ c.m}^2$

Floor area =  $5 \times 7.3 \text{ m}^2$

$$\% \text{ Area} = \frac{6 \times 10 \times 10}{5 \times 7.3 \times (100)^2} \times 100 = 0.1 \quad \text{Ans.}$$

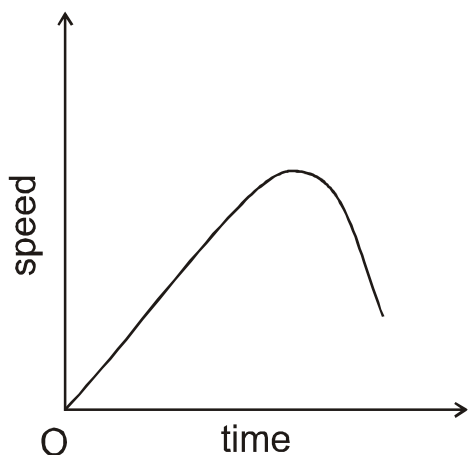

3.(2)

Given that the graph between the speed and time.

From the figure it is clear that speed is changing with time. In starting it increases and then decrease so that means at any instance speed will be zero. We know that acceleration is directly proportional to velocity. So the acceleration will be zero once on the path.



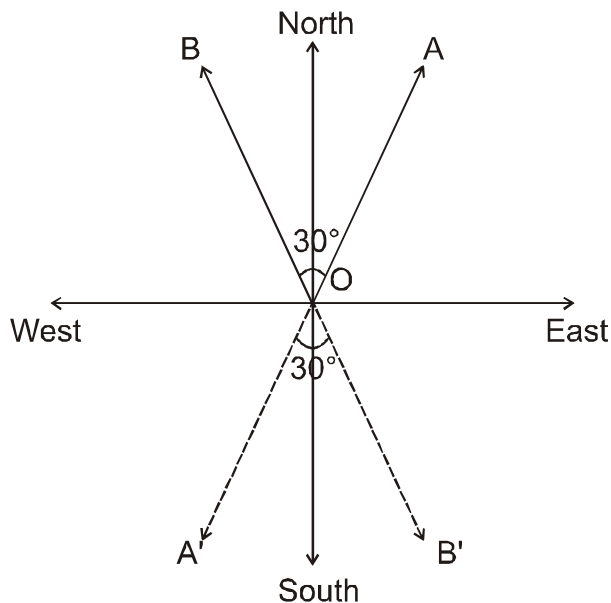

4.(3)

From the fig  $\angle BOA = 30^\circ = \angle A'OB'$  ( $\because$  these are alternate angles)

So the direction of hill B from hill A is N30°E or S30°E

S30°E given in option (3).

Option (3) is correct.

5.(2) The percentage of variability over the average of that year

$$\text{year 2000} \rightarrow \left( \frac{50}{150} \times 100 \right) = 33.33\%$$

$$\text{year 2001} \rightarrow \left( \frac{75}{250} \times 100 \right) = 30\%$$

$$\text{year 2002} \rightarrow \left( \frac{75}{200} \times 100 \right) = 37.5\%$$

$$\text{year 2003} \rightarrow \left( \frac{50}{100} \times 100 \right) = 50\%$$

Thus it is least for the year 2001.

6.(3) No. of students are x.

$$\frac{20}{100} \times x = \frac{x}{5} \quad \text{- get job, in 1st year}$$

remaining students  $x - \frac{x}{5} = \frac{4}{5}x$

$$\frac{20}{100}x - \frac{4}{5}x = \frac{4}{5}x \text{ get job in II year}$$

$$\frac{4}{5}x - \frac{4}{25}x = 16$$

$$\frac{20x - 4x}{25} = 16$$

$$16x = 25 \times 16$$

$$x = 25$$

so no. of students are 25.

7.(4) Volume of cylinder =  $\pi r^2 h$  ... (1)

where h is the height of water level.

After dipping, Let height become h'

then volume of cylinder =  $\pi r^2 h'$  ... (2)

Volume of hemisphere of radius r/2 is  $= \frac{2}{3}\pi\left(\frac{r}{2}\right)^3$  ... (3)

It is clear that

equation (1) + (3) = (2)

$$\Rightarrow \frac{2}{3}\pi\frac{r^3}{8} + \pi r^2 h = \pi r^2 h', \quad \Rightarrow \quad h' - h = \frac{r}{12} \quad \text{Ans.}$$

8.(3)

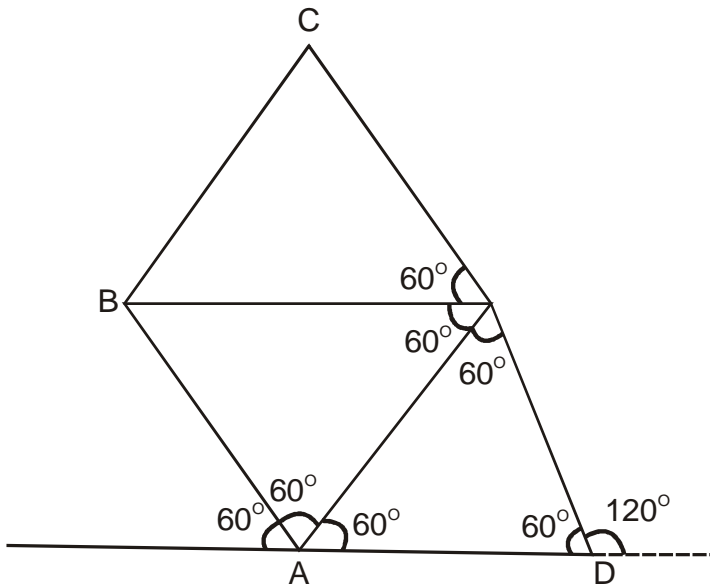

trapezium is 'A B C D' .

The length of the longer of the two parallel sides of trapezium is 10 cm.

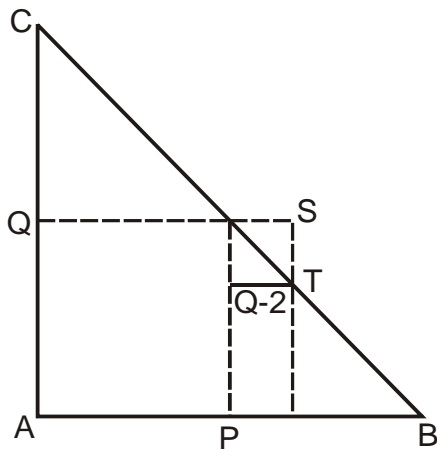

9.(3)

$$AB = AC = 3$$

$$AQ = 2 AP$$

$$\text{Area of } \triangle ABC = \frac{1}{2} b \times h = \frac{1}{2} (3 \times 3) = \frac{9}{2}$$

$$\text{Area of } \triangle QST = \frac{1}{2} (Q/2 \times Q/2) = \frac{Q^2}{8}$$

$$\text{Ratio} = \frac{9 \times 100}{2 \times Q^2} = 225$$

10.(3) Total possible cases.

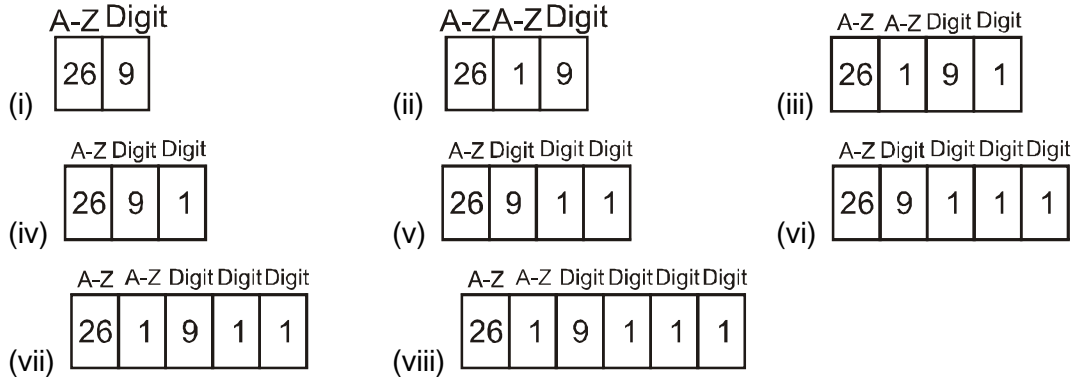

Total 8 type of configurations. Product of entries in each = 234

Total =  $234 \times 8 = 1872$

A O Q E  
 C M S C  
 E K 4 A  
 G I W Y

11.(4)

Solution one letter is missing alternate are giving.

A \_ O  
 B \_ N  
 C \_ M  
 D \_ L  
 E \_ K  
 F \_ J  
 G → H → I

12.(2) For maximum  $\frac{X}{Y} \Rightarrow X = \text{maximum} = 5; Y = \text{minimum} = 8$

$$\Rightarrow \text{maximum } \frac{X}{Y} = \frac{5}{8}$$

For minimum  $\frac{X}{Y} \Rightarrow X = \text{minimum} = 3; Y = \text{maximum} = 11$

$$\Rightarrow \frac{X}{Y} = \frac{3}{11}$$

13.(3)  $y = 5x^2 + 3$

$$y' = 5(2x) = 10(x)$$

$$y' = 10x$$

$$= m$$

equation of a tangent which passes through the point (0,3)

$$y - y_1 = m(x - x_1)$$

$$y - 3 = m(x - 0)$$

$$y - 3 = mx$$

$$y - 3 = 0$$

$$y = 3 \quad (1)$$

This is the equation of the tangent and it is parallel to the x axis because  $y = \text{constant} = \text{parallel to the x axis}$ .

14.(2) If the price is  $x$  (at 20% discount), then  $(x) \cdot .8 = 192$ ; so  $x = 192 / .8 = 240$ ;

If the full price is  $Y$  then  $Y \cdot .8 = 240$ ;  $Y = 240 / .8 = 300$

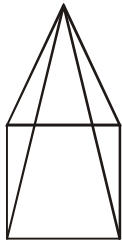

15.(3)

Pyramid have total 8 edge.

As we want 8 strands so by keeping wire like

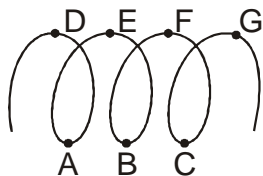

A, B, C put in one time and D, E, F, G in next time.

16.(4) Pole is at  $z = 0$

$$\text{circle } |z - 2| = 1 \Rightarrow \oint \frac{e^z \sin z}{z^2} dz = 2\pi i \times 0 = 0$$

17.(4)  $L\{f(x)\} = \int_0^\infty e^{-sx} f(x) dx = \int_3^3 e^{-sx} f(x) dx + \int_3^\infty e^{-sx} f(x) dx = \int_3^\infty (x-3)e^{-sx} dx$

$$L\{f(x)\} = (x-3) \frac{e^{-sx}}{-s} \Big|_3^\infty - \int_3^\infty 1 \cdot \left( \frac{e^{-sx}}{-s} \right) dx = 0 - \frac{1}{s} \int_3^\infty e^{-sx} dx$$

$$L\{f(x)\} = \frac{1}{s} \left[ \frac{e^{-sx}}{-s} \right]_3^\infty = s^{-2} e^{-sx}$$

18.(4) For coF ;  $(D^2 - 1)y = 0$ ,  $m = \pm 1 \Rightarrow C.F = c_1 e^t + c_2 e^{-t}$

$$P.I = \frac{1}{D^2 - 1} 2 \cos ht = \frac{1}{D^2 - 1} 2 \left( \frac{e^t + e^{-t}}{2} \right)$$

$$= \frac{1}{D^2 - 1} e^t + \frac{1}{D^2 - 1} e^{-t} = \frac{t}{2} e^t + \frac{t}{2} (e^{-t})$$

$$\Rightarrow y = c_1 e^t + c_2 e^{-t} + \frac{t}{2} e^t - \frac{t}{2} e^{-t}$$

$$\Rightarrow y(0) = 0 \Rightarrow c_1 + c_2 = 0$$

$$\frac{dy}{dt} = c_1 e^t - c_2 e^{-t} + \frac{t}{2} e^t + \frac{1}{2} e^t + \frac{t}{2} e^{-t} - \frac{1}{2} e^{-t}$$

$$\frac{dy}{dt} \Big|_{t=0} = 0 \Rightarrow c_1 - c_2 + 0 + \frac{1}{2} + 0 - \frac{1}{2} = 0$$

$$c_1 - c_2 = 0 \Rightarrow c_1 = 0, c_2 = 0$$

Thus  $\Rightarrow y = \frac{t}{2} e^t - \frac{t}{2} e^{-t} \Rightarrow y = t \sinh t$

So, the solution of the diff. eq<sup>n</sup> is

$$y = t \sinh t$$

19.(2) We know that Escape velocity =  $\sqrt{2gR}$

$$\frac{\text{Escape velocity of earth}}{\text{Escape velocity of mass}} = \sqrt{\frac{g_e R_e}{g_m R_m}}$$

$$\frac{R_e}{R_m} = \frac{3}{4} \quad \& \quad \frac{g_e}{g_m} = 2.3$$

$$\frac{V_e}{v_m} = \sqrt{\frac{3}{4} \times 2.3} = 1.3$$

20.(2)  $\tau^- \rightarrow \pi^- + \nu_\tau$

From conservation of energy

$$M_\tau c^2 = E_\pi + E_\nu$$

$$E_\pi^2 = p^2 c^2 + M_\pi^2 c^4 \quad \text{and}$$

$$E_\nu^2 = p^2 c^2 \quad \text{since momentum of } \pi^- \text{ and } \nu_\tau \text{ is same}$$

$$M_\tau c^2 = E_\pi + E_\nu, \quad M_\pi^2 c^4 = E_\pi^2 - E_\nu^2 = E_\pi - E_\nu = \frac{M_\pi^2 c^4}{M_\tau c^2}$$

$$E_\pi - E_\nu = \frac{M_\pi c^2}{M_\tau}$$

$$\text{and } E_\pi + E_\nu = M_\tau c^2 \Rightarrow E_\pi = \left( \frac{M_\tau^2 + M_\pi^2}{2M_\tau} \right) c^2$$

21.(4)  $H = xP_x - yP_y + \frac{1}{2} y^2 - \frac{1}{2} x^2$

$$\frac{\partial H}{\partial x} = -\dot{P}_x \Rightarrow P_x - x = -\dot{P}_x$$

$$\frac{\partial H}{\partial y} = -\dot{P}_y \Rightarrow -P_y + y = -\dot{P}_y$$

$$\frac{\partial H}{\partial x} = \dot{x} \Rightarrow x = \dot{x}$$

$$\text{and } \frac{\partial H}{\partial y} = \dot{y} \Rightarrow -y = \dot{y}$$

After solving four differential equation and eliminating time t and using boundary condition one will get x =

$$\frac{1}{x} \quad \&$$

$$P_x = \frac{1}{2P_y}$$

Both results satisfy by hyperbola equation.

$$22.(1) \quad \vec{E} = \vec{E}_0 \cos(\vec{K} \cdot \vec{r} - \omega t)$$

$$\vec{B} = \frac{\vec{K} \times \vec{E}_0}{c} \cos(\vec{K} \cdot \vec{r} - \omega t)$$

Power crossing the loop is

$$\vec{P} = \vec{A} \cdot \left( \vec{E} \times \frac{\vec{B}}{\mu_0} \right)$$

$$= \frac{1}{\mu_0 c} \vec{A} \cdot \vec{E}_0 \times (\vec{K} \times \vec{E}_0) \cos^2(\vec{K} \cdot \vec{r} - \omega t)$$

$$\langle P \rangle = \frac{1}{\mu_0} \vec{A} \cdot [\vec{K} \vec{E}_0] \langle \cos^2(\vec{K} \cdot \vec{r} - \omega t) \rangle$$

$$= \frac{1}{2\mu_0 c} E_0^2 \vec{A} \cdot \vec{K}$$

$$23.(1) \quad E = E_0 \exp[i(\vec{k} \cdot \vec{r} - \omega t)]$$

$$\nabla^2 E = k^2 E_0 \exp[i(\vec{k} \cdot \vec{r} - \omega t)]$$

$$\nabla^2 E = k^2 E$$



$$\frac{\partial^2 \mathbf{E}}{\partial t^2} = \omega^2 \mathbf{E}$$

$$\nabla^2 \mathbf{E} = \frac{1}{c^2} \left[ \frac{\partial^2 \mathbf{E}}{\partial t^2} + \omega'^2 \mathbf{E} \right]$$

$$k^2 \mathbf{E} = \frac{1}{c^2} [\omega^2 \mathbf{E} + \omega'^2 \mathbf{E}]$$

$$c^2 k^2 = \omega^2 + \omega'^2$$

$$\omega^2 = c^2 k^2 - \omega'^2$$

24.(2) The equation of motion of accelerated charge in sinusoidally varying electric field  $\vec{E}$  is given by

$$m \vec{a} = q \vec{E} \Rightarrow \frac{d^2 \vec{r}}{dt^2} = \frac{q \vec{E}_0}{m} e^{-i\omega t}$$

$$\vec{r} = \frac{-q \vec{E}_0}{m \omega^2} e^{-i\omega t} \quad \text{But } \vec{p} = q \vec{r}$$

$$= \frac{-q^2 \vec{E}_0}{m \omega^2} e^{-i\omega t}$$

$$|\vec{p}| = \left| -\frac{q^2 \vec{E}_0}{m \omega^2} e^{-i\omega t} \right|$$

$$p_0 e^{-i\omega t} = \left| -\frac{q^2 \vec{E}_0}{m \omega^2} \right| e^{-i\omega t}$$

$$p_0 = \left| \frac{q^2 \vec{E}_0}{m \omega^2} \right| = \frac{q a}{\omega^2}$$

$$\vec{a} = \frac{q \vec{E}_0}{m^2}$$

25.(4)  $A \psi_1 = \psi_2$  &  $A \psi_2 = \psi_1$

$$\Rightarrow \int \psi^* A \psi dx = \int \left( \frac{3\psi_1 + 4\psi_2}{5} \right) A \left( \frac{3\psi_1 + 4\psi_2}{5} \right) dx$$

$$\Rightarrow \int \psi^* A \psi dx = \frac{1}{25} \int (3\psi_1 + 4\psi_2) (4\psi_1 + 3\psi_2) dx$$

$$\int \psi^* A \psi dx = \frac{1}{25} \left[ (3 \times 4) \int \psi_1^2 dx + 3 \times 4 \int \psi_2^2 dx \right] = \frac{24}{25} = 0.96$$

26.(3) Normalization constant  $\int |\psi(x)|^2 dx = 1$

Therefore, we check whether  $\int |\psi(x)|^2 dx = 1$  or not  $\int |\psi(x)|^2 dx = \int_{-\infty}^{\infty} \frac{(1+x^2)}{(1+x^4)} dx$

But the particle is most likely to be found where  $|\psi(x)|^2$  is maximum, or

$$|\psi(x)|^2 \text{ is maximum where } \frac{d}{dx} |\psi(x)|^2 = 0$$

$$\frac{d}{dx} \left( \frac{1+x^2}{1+x^4} \right) = \frac{2x}{1+x^4} - \frac{(1+x^2)4x^3}{(1+x^4)^2}$$

$$\Rightarrow 2x(1+x^4) = 4x^3(1+x^2)$$

$$\Rightarrow x^4 + 2x^2 - 1 = 0$$

$$x^2 = \frac{-2 + \sqrt{4+4}}{2} = \sqrt{2} - 1$$

$$x = \pm \sqrt{\sqrt{2} - 1}$$

The particle is most likely to found  $x = \pm \sqrt{\sqrt{2} - 1}$

27.(1) Here  $v(x) = 0$  for  $0 \leq x \leq \pi$   
 $= \infty$  otherwise

Applying schrodinger equation

$$\frac{d^2 \psi}{dx^2} + \frac{2m}{\hbar^2} (E - v) \psi = 0$$

$$\frac{d^2 \psi}{dx^2} + \frac{2m}{\hbar^2} E \psi = 0$$

$$\Psi = A \cos kx + B \sin kx$$

Applying boundary conditions  $\Psi(0) = \Psi(\pi) = 0$

$$A = 0$$

$\Psi = B \sin kx \Rightarrow$  Applying normalization

$$\int_0^{\pi} \Psi \Psi^* dx = 1$$

$$B^2 \int_0^{\pi} \sin^2 kx dx = 1 \Rightarrow B^2 \int_0^{\pi} \left( \frac{1 - \cos 2kx}{2} \right) dx = 1$$

$$B^2 \left[ \left( \frac{\pi}{2} \right) - \frac{1}{4k} (\sin 2kx) \Big|_0^{\pi} \right] = 1$$

$$B = \sqrt{\frac{2}{\pi}} \Rightarrow \Psi = \sqrt{\frac{2}{\pi}} \sin kx$$

The energy correction due to  $H' = ax$  is

$$\langle E \rangle = \int_0^{\pi} \Psi^* H' \Psi dx$$

$$\langle E \rangle = \frac{2a}{\pi} \int_0^{\pi} x \sin^2 kx dx$$

$$\Rightarrow E = \frac{a\pi}{2}$$

29.(3)  $E_0 = 0, E_1 = E$

$$z = \sum e^{-\beta E_i} \Rightarrow z = e^{-\beta \cdot 0} + e^{-\beta E}$$

$$\ln z = \ln(1 + e^{-\beta E})$$

$$U = \langle E \rangle = \frac{-\partial}{\partial \beta} \ln z = \frac{-\partial}{\partial \beta} \ln(1 + e^{-\beta E})$$

$$U = \frac{1}{(1 + e^{-\beta E})} (-E) e^{-\beta E}$$

$$U = \frac{E e^{-\beta E}}{1 + e^{-\beta E}} \quad \therefore \quad \beta = KT$$

$$\left(\frac{\partial U}{\partial T}\right)_V = C_V = \frac{(1 + e^{-E/KT})E \cdot e^{-\frac{E}{KT}} \cdot \left(\frac{E}{KT^2}\right) - E \cdot e^{-E/KT} \cdot e^{-\frac{E}{KT}} \left(\frac{E}{KT^2}\right)}{\left(1 + e^{-\frac{E}{KT}}\right)^2}$$

$$C_V = \frac{\frac{E^2}{KT^2} e^{-\frac{E}{KT}} + \frac{E^2}{KT^2} e^{-\frac{2E}{KT}} - \frac{E^2}{KT^2} e^{-\frac{2E}{KT}}}{\left(1 + e^{-\frac{E}{KT}}\right)^2} = \frac{E^2 e^{-\frac{E}{KT}}}{KT^2 \left(1 + e^{-\frac{E}{KT}}\right)^2}$$

If gas will classically allowed then  $C_V = \frac{3}{2}K$

$$C_V = \frac{E^2 e^{-\frac{E}{KT}}}{KT^2 \left(1 + e^{-\frac{E}{KT}}\right)^2}$$

and due to quantum mechanically

$$\therefore C_V = \frac{3}{2}K + \frac{E^2 e^{E/KT}}{KT^2 \left(1 + e^{E/KT}\right)^2}$$

**30.(4)** from magnetostatic Boundary conditions

$$B_{\text{above}}^{11} - B_{\text{below}}^{11} = \mu_0 (K \times \hat{n})$$

$\therefore$  Given  $\vec{k} = k\hat{j}$

And  $\hat{n} = \hat{i} + \hat{j}$

$$\begin{aligned} B_{\text{above}}^{11} - B_{\text{below}}^{11} &= \mu_0 K (\hat{j} \times (\hat{i} + \hat{j})) \\ &= \mu_0 K [\hat{j} \times \hat{i} + 0] \end{aligned}$$

$$B_{\text{above}}^{11} - B_{\text{below}}^{11} = -\mu_0 K \hat{k}$$

So magnetic field is directed along  $-\hat{k}$  for  $z > 0$  and along  $+\hat{k}$  for  $z < 0$ .

$$d = \frac{1}{\sqrt{\frac{h^2}{a^2} + \frac{k^2}{b^2} + \frac{\ell^2}{c^2}}}$$

**31.(3)**

Given that  $h = 1, k = 0, \ell = 1$

For tetragonal and

$$a_t = b_t = \sqrt{2}a_c \quad c_t = 2a_c$$

then 
$$d_t = \frac{1}{\sqrt{\frac{1^2}{2a_c^2} + 0 + \frac{1^2}{4a_c^2}}}$$

$$d_t = \frac{a_c}{\sqrt{\frac{1}{2} + \frac{1}{4}}} \Rightarrow d_t = \frac{a_c}{\sqrt{\frac{3}{4}}} = \frac{2a_c}{\sqrt{3}}$$

for cubic  $a_t = b_t = c_t$

then 
$$d_c = \frac{1}{\sqrt{\frac{1}{a_c^2} + 0 + \frac{1}{a_c^2}}} = \frac{a_c}{\sqrt{2}}$$

Now 
$$\frac{d_c}{d_t} = \frac{a_c}{\sqrt{2}} \times \frac{\sqrt{3}}{2a_c} = \frac{\sqrt{3}}{2\sqrt{2}} = \sqrt{\frac{3}{8}} = \sqrt{0.375}$$

32.(1) The free energy in three dimension is defined as

$$E_f = \frac{\hbar^2}{2m} \left( \frac{3\pi^2 N}{v} \right)^{2/3} = \frac{\hbar^2}{2m} (3\pi^2 n)^{2/3}$$

The pressure of a nonrelativistic free fermi gas is defined as

$$P_f = - \left( \frac{\partial E}{\partial v} \right) = \frac{3}{5} \times N \times \frac{\hbar^2}{2m} (3\pi^2 N)^{2/3} \times \left( \frac{-2}{3} \right) v^{-5/3}$$

$$P_f = \frac{2}{5} n E_f = \frac{2}{5} \times n \times \frac{\hbar^2}{2m} (3\pi^2 n)^{2/3}$$

$$P_f = \frac{2}{5} \frac{\hbar^2}{2m} (3\pi^2)^{2/3} n^{5/3}$$

33.(3) is correct

$$\beta = 50 = > < = \frac{\beta}{\beta + 1} = \frac{50}{51}$$

$$\alpha = \beta^* \times \gamma$$

$$\beta^* = \left( \frac{50}{51} \right) \left( \frac{1}{0.995} \right) = 0.9853 \square$$

**0.985**

34.(3)  $L = \frac{1}{2}m[\dot{x}^2 + \dot{y}^2 + \dot{z}^2] - mgz$

Where  $ax^2 + ay^2 - 2z = 0$

It has cylindrical symmetric. Thus  $x = r \cos \phi$ ,  $y = r \sin \phi$ ;  $z = \frac{1}{2}a(r^2)$

$$\dot{x} = \dot{r} \cos \phi - r \sin \phi \dot{\phi}$$

$$\dot{y} = \dot{r} \sin \phi + r \cos \phi \dot{\phi}$$

$$\dot{z} = a(r\dot{r})$$

so, 
$$L = \frac{1}{2}m \left[ (1 + a^2r^2)\dot{r}^2 + r^2\dot{\phi}^2 - ga^2r^2 \right]$$

35.(1) Primitive vector ( $\hat{A}$ )

$$\vec{a} = 2(\hat{j} + \hat{k}) \quad \vec{b} = 2(\hat{k} + \hat{i}), \quad \vec{c} = 2(\hat{i} + \hat{j})$$

A two-dimensional lattice space. This is the primitive vector of "FCC" lattice "BCC" lattice is the reciprocal lattice of "FCC" lattice having following reciprocal vectors

$$\vec{a}_1 = \frac{\pi}{2}[-\hat{i} + \hat{j} + \hat{k}]$$

$$\vec{b}_1 = \frac{\pi}{2}[\hat{i} - \hat{j} + \hat{k}]$$

$$\vec{c}_1 = \frac{\pi}{2}[\hat{i} + \hat{j} - \hat{k}]$$

So, reciprocal lattice of FCC is "BCC" lattice with cube edge of  $\frac{\pi}{2}$

36.(4) There are 64 words in a block.

4K cache has  $\frac{4 \times 1024}{64} = 64$  block.

since 'l' set has 4 blocks, There are 16 sets. '16'sets heed a 4- bit representation. In a set there are 4 blocks. So the block field needs 2 bits each block has 64 words. So the word field has 6 bits.

37.(3) According to Bragg's how  $2d \sin \theta = \lambda$

$$\text{where } d = \frac{a}{\sqrt{h^2 + k^2 + l^2}} = \frac{a}{\sqrt{1+1+1}} = \frac{a}{\sqrt{3}} \text{ for (111) plane}$$

$$\frac{\lambda}{2d} = \frac{a}{2 \times \frac{a}{\sqrt{3}}} = \frac{\sqrt{3}}{2} \Rightarrow \theta = \sin^{-1} \left( \frac{\sqrt{3}}{2} \right) = \frac{\pi}{3}$$

$$\Rightarrow \sin \theta =$$

38.(2) The relation between critical field and critical temperature is

$$H_c(T) = H_0 \left[ 1 - \left( \frac{T}{T_c} \right)^2 \right]$$

$$\text{Let } T = T_1, H_c(T_1) = T = T_2$$

$$T_c(T) = H_c(T_2)$$

$$H_c(T_1) = H_0 \left[ 1 - \left( \frac{T_1}{T_c} \right)^2 \right]$$

Thus we get

$$H_c(T_2) = H_0 \left[ 1 - \left( \frac{T_2}{T_c} \right)^2 \right]$$

$$\frac{H_c(T_1)}{H_c(T_2)} = \frac{1 - \left( \frac{T_1}{T_c} \right)^2}{1 - \left( \frac{T_2}{T_c} \right)^2}$$

$$T_c = \sqrt{\frac{H_c(T_1) T_2^2 - T_1^2}{H_c(T_2) T_2^2 - T_1^2}} = \sqrt{\frac{2(8)^2 - 4^2}{2 - 1}} \approx 10.6$$

$$\Rightarrow H_c(T_1) = 11 \text{ mA/M}$$

$$H_c(T_2) = 5.5 \text{ mA/M}$$

40.(1) By the thermodynamic relations we know that

(i)  $dU = TdS - PdV$

at constant S and V  $dU = 0$

(ii)  $dF = -PdV - SdT$

at constant temperature and volume  $dF = 0$

(iii)  $dH = TdS + VdP$

at constant entropy and pressure

$$dH = 0$$

(iv)  $dG = VdP - SdT$

at constant temp. and pressure  $dG = 0$

41.(3) Given that

$n$  particle  $\rightarrow$  parallel to  $\vec{B}$

$(N - n)$  particle  $\rightarrow$  antiparallel to  $\vec{B}$

$$\Omega = \frac{N!}{n!(N - n)!}$$

Now  $E_1 = -n\mu B$

$$E_2 = -(N - n)(-\mu B) = (N - n)\mu B$$

Total energy of the system  $E = (N - 2n)\mu B$

$$\frac{\partial E}{\partial n} = -2\mu B$$



Again  $\ln \Omega = \ln N! - \ln n! - \ln (N-n)!$

$\Rightarrow$  Entropy  $s = k \ln \Omega$

$$\frac{\partial s}{\partial n} = k \left[ -\ln n - 1 + \ln(N-n) + \frac{N-n}{N-n} \right]$$

$$\frac{\partial s}{\partial n} = k \left[ \ln \left( \frac{N-n}{n} \right) \right]$$

$$\frac{\partial s}{\partial E} = \frac{1}{T} \Rightarrow \frac{-k}{2\mu B} \ln \left( \frac{N-n}{n} \right) = \frac{1}{T}$$

$$T = \frac{-2\mu B}{k \ln \left( \frac{N-n}{n} \right)}$$

$$\frac{-kT}{2\mu B} = \frac{1}{\ln \left( \frac{N-n}{n} \right)}$$

$$\frac{n}{N} = \frac{1}{1 + \exp \left( -\frac{2\mu B}{kT} \right)}$$

**42.(4)** If both particle will in ground state the energy will 0 which is non degenerate.

If one particle is in ground state and other is in first excited state then energy is  $\epsilon$  and non degenerate.

If both particle will in first excited state the energy will  $2\epsilon$  which is non degenerate.

$$\text{Average value of energy} = \frac{1}{Z} (e^{-\beta\epsilon} + 2\epsilon e^{-2\beta\epsilon})$$

$$\text{where partition function } z = 1 + e^{-\beta\epsilon} + 2\epsilon e^{-2\beta\epsilon}$$

**44.(2)** Given that, Taylor expansion of the function is given by  $f(x) = \ln(\cos x)$  where  $x$  is real.

Now, Taylor expansion of the function about the point  $x_0 = 0$  is,

$$f(x_0) = f(x_0) + (x - x_0) f'(x_0) + \frac{(x - x_0)^2}{2!} f''(x_0) + \dots$$

Now,  $f(x_0) = \ln \cosh x|_{x=0} = \ln 1 = 0$

$$f'(x_0) = \left. \frac{d}{dx} (\ln \cosh x) \right|_{x=0} = \frac{1}{\cosh x} \sinh x = 0$$

$$f''(x_0) = \left. \frac{d^2}{dx^2} (\ln \cosh x) \right|_{x=0} = \left. \frac{d}{dx} \left( \frac{\sinh x}{\cosh x} \right) \right|_{x=0}$$

$$\frac{\cosh x \cosh x - \sinh x \sinh x}{(\cosh x)^2} = 1$$

$$f'''(x) = 0 \text{ and } f'''(x_0) = \left. \frac{d^3}{dx^3} (\ln \cosh x) \right|_{x=0} = -2$$

Now, put these values

$$f(x) = 0 + 0 + \frac{x^2}{2} + 0 - \frac{x^4}{4!} + \dots$$

$$= \frac{x^2}{2} - \frac{x^4}{2 \times 3 \times 4} \times 2 = \frac{x^2}{2} - \frac{x^4}{12} + \dots$$

45.(1) Let the unitary matrix U is defined as

$$U = \begin{pmatrix} \alpha & 0 \\ 0 & \alpha \end{pmatrix}$$

Given that  $\det(U) = |U| = e^{i\phi}$

$$\begin{vmatrix} \alpha & 0 \\ 0 & \alpha \end{vmatrix} = e^{i\phi} \text{ or } \alpha^2 = e^{i\phi}$$

$$\alpha = e^{i\phi/2}$$

$$\text{Hence } U = \begin{pmatrix} e^{i\phi/2} & 0 \\ 0 & e^{i\phi/2} \end{pmatrix}$$

Now, multiplying u by  $e^{i\phi/2}$ , we get

$$V = e^{-i\phi/2} \cdot U = e^{-i\phi/2} \begin{pmatrix} e^{i\phi/2} & 0 \\ 0 & e^{i\phi/2} \end{pmatrix} = \begin{pmatrix} 1 & 0 \\ 0 & 1 \end{pmatrix}$$

$$\text{So, det } (V) = |V| = \begin{vmatrix} 1 & 0 \\ 0 & 1 \end{vmatrix} = 1$$

$$46.(4) \quad \frac{dp}{dt} = F \Rightarrow P = Ft + c$$

At  $t = 0$ ,  $P = 0$  so  $c = 0$

$$\Rightarrow P = Ft = \frac{mu}{\sqrt{1 - \frac{u^2}{c^2}}} = Ft \Rightarrow u = \frac{\frac{F}{m}t}{\sqrt{1 + \left(\frac{Ft}{mc}\right)^2}}$$

$$u = \frac{Fct}{\sqrt{F^2t^2 + m^2c^2}}$$

$$47.(1) \quad v(r) = \frac{P}{r^{12}} - \frac{q}{r^6} \quad \text{for equilibrium } \frac{\partial v}{\partial r} = 0$$

$$\Rightarrow (-6) \frac{q}{r^7} - \frac{12p}{r^{13}} = 0 \Rightarrow \frac{1}{r^7} \left[ 6q - \frac{12p}{r^6} \right] = 0$$

$$= 6a - \frac{12p}{r^6} = 0 \Rightarrow r = \left( \frac{12p}{q} \right)^{1/6}$$

$$\Rightarrow v|_r = \left(\frac{2p}{q}\right)^{1/6} = \frac{-q}{\left(\frac{2p}{q}\right)} + \frac{p}{\left(\frac{12p}{q}\right)^2}$$

$$V = \frac{-q^2}{2p} + \frac{q^2}{4p} = \frac{-q^2}{4p}$$

48.(4)  $V_{\text{eff}} = \frac{J^2}{2mr^2} + \frac{1}{2}kr^2$  where J is angular momentum condition for circular orbit

$$\frac{dV_{\text{eff}}}{dt} = 0 \Rightarrow \frac{-J^2}{mr^3} + kr = 0$$

$$\Rightarrow J^2 \propto r^4 \Rightarrow J \propto r^2$$

Thus  $\frac{J_1}{J_2} \frac{r_1^2}{r_2^2} \Rightarrow \frac{r_1}{r_2} = \sqrt{\frac{J_2}{J_1}}$  given that  $\frac{J_2}{J_1} = 4$

$$\frac{r_1}{r_2} = \sqrt{\frac{1}{4}} = \frac{1}{2}$$

49.(1) According to snell's law

$$\frac{\sin \theta_i}{\sin \theta_T} = {}_1n_2$$

$$\theta_i = 45^\circ \text{ and } {}_1n_2 = 1.5$$

$$\sin \theta_T = \frac{\sin \theta_i}{{}_1n_2} = \frac{\sin 45^\circ}{1.5} = \frac{1}{\sqrt{2}\sqrt{1.5}}$$

$$\theta_T = \sin^{-1} \left( \frac{1}{2.121} \right) = 28.1^\circ$$

$$R_{\parallel} = \frac{\sin^2(\theta_i - \theta_T)}{\sin^2(\theta_i + \theta_T)} = \frac{\sin^2(16.9)}{\sin^2(73.1)}$$

$$= \left( \frac{0.2924}{0.9568} \right)^2 = 0.93392$$

$$R_{\perp} = \frac{\tan^2(\theta_i - \theta_T)}{\tan^2(\theta_i + \theta_T)} = \frac{\tan^2(16.9)}{\tan^2(73.1)}$$

$$= 0.008526$$

Degree of polarization

$$P(Q) = \frac{R_{\perp} - R_{\parallel}}{R_{\perp} + R_{\parallel}}$$

$$\frac{\partial^2 v}{\partial x^2} + \frac{\partial^2 v}{\partial y^2} = 0$$

50.(1) The configuration is independent of Z. then by the Laplace's equation

$$\left. \begin{aligned} v = 0, y = 0 \\ v = 0, y = a \\ v = v_0, x = b \\ v = v_0, x = -b \end{aligned} \right\}$$

and the boundary conditions =

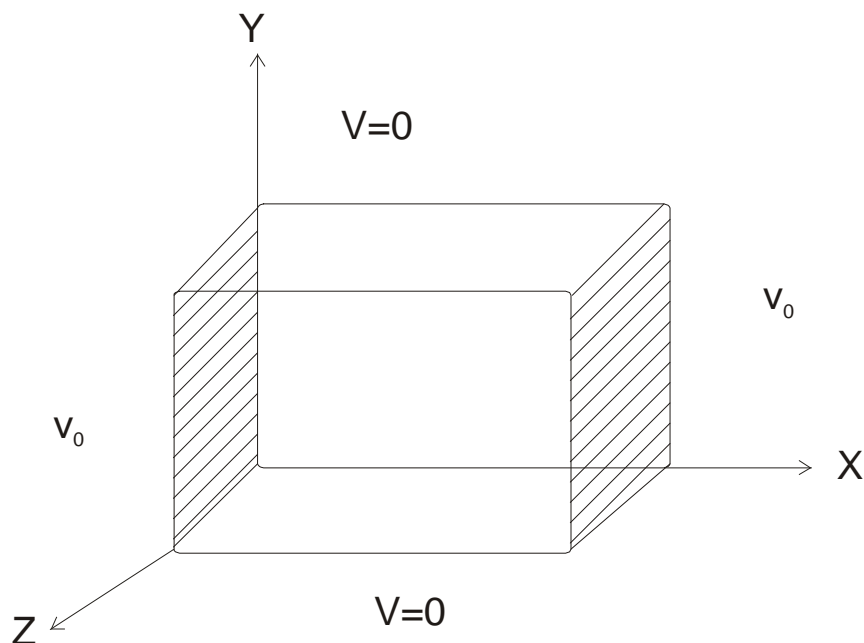

$$v(x, y) = (Ae^{kx} + Be^{-kx})(C \sin ky + D \cos ky)$$

But  $V(-x, y) = V(x, y)$

$$e^{kx} + e^{-kx} = 2 \cosh kx$$

$$V(x, y) = \cosh x (c \sin ky + D \cos ky)$$

$$D = 0 \text{ and } k = \frac{n\pi}{a} \text{ so}$$

$$v(x, y) = c \cosh(n\pi x/a) \sin(n\pi y/a)$$

$$v(x, y) = \sum_{n=1}^{\infty} c_n \cosh\left(\frac{n\pi x}{a}\right) \sin\left(\frac{n\pi y}{a}\right)$$

$$v(b, y) = \sum_{n=1}^{\infty} c_n \cosh\left(\frac{n\pi b}{a}\right) \sin\left(\frac{n\pi y}{a}\right) = v_0$$

$$c_n \cosh\left(\frac{n\pi b}{a}\right) = \begin{cases} 0 & \text{if } n \text{ is even} \\ \frac{uv_0}{n\pi} & \text{if } n \text{ is odd.} \end{cases}$$

$$v(x, y) = \frac{uv_0}{\pi} \sum_{n=1,3,5} \frac{1}{n} \frac{\cosh(n\pi x/a)}{\cosh(n\pi b/a)} \sin n\pi y/a$$

51.(3) The volume bound charge density

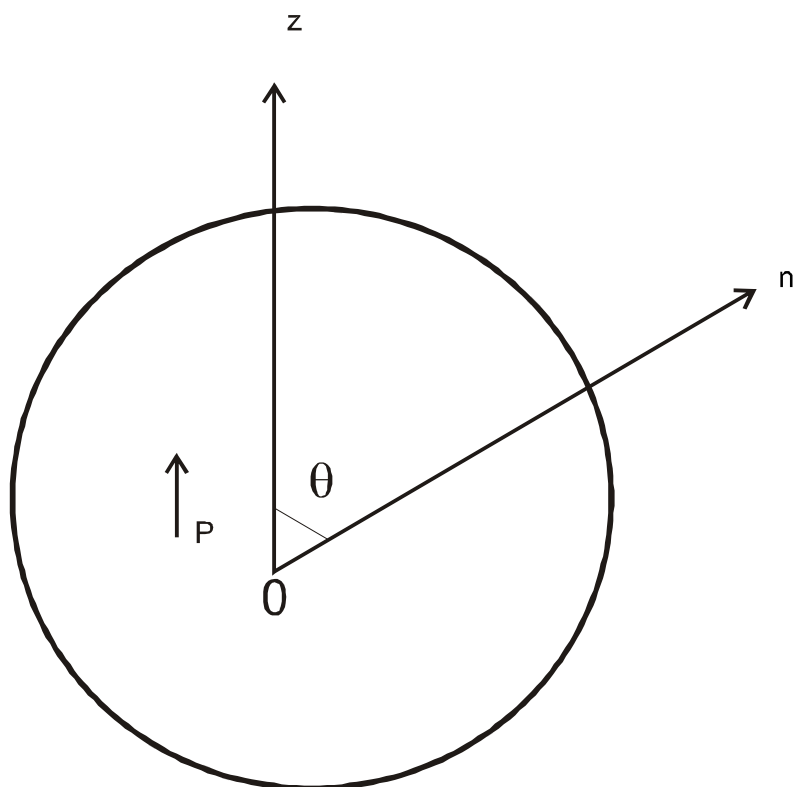

$\theta$   $P_b$  is zero, since  $P$  is  $p \cos \theta$

$\sigma_b$  is zero, since  $P$  is uniform

but  $\sigma_b = P \cdot \hat{n} = P \cos \theta$

$$v(r, \theta) \begin{cases} \frac{P}{3\epsilon_0} r \cos \theta & \text{for } r \leq R \\ \frac{P}{3\epsilon_0} \frac{R^3}{r^2} \cos \theta & \text{for } r \geq R \end{cases}$$

$r \cos \theta = z$ , the field inside the sphere is uniform

$$E = -\nabla v = \frac{-P}{3\epsilon_0} z' = \frac{-P}{3\epsilon_0} = \frac{-P}{3\epsilon_0}$$

for  $r < R$  outside the sphere the potential is identical to that of a perfect dipole at the origin.

$$v = \frac{P \cdot \hat{r}}{4\pi \epsilon_0 r^2} \text{ for } r \leq R$$

52.(3)  $H = \alpha S_z + \beta \vec{S}_1 \cdot \vec{S}_2$

$$S_z = S_{1z} + S_{2z}$$

$$\vec{S}_1 \cdot \vec{S}_2 = \frac{1}{2} [S^2 - S_1^2 - S_2^2]$$

For triplet  $s = 1$

$$S_z = +1, 0, -1$$

$$\vec{S}_1 \cdot \vec{S}_2 = \frac{1}{2} \left( 2 - \frac{3}{2} \right) = \frac{1}{4}$$

For singlet  $S = 0$

$$S_z = 0$$

$$\vec{S}_1 \cdot \vec{S}_2 = \frac{1}{2} \left( 0 - \frac{3}{2} \right) = -\frac{3}{4}$$

$$E_{\text{singlet}} = \frac{-3\beta}{4}$$



$$E_{\text{triplet}} = \begin{cases} \alpha + \frac{\beta}{4} & ; s_z = 1 \\ \frac{\beta}{4} & ; s_z = 0 \\ -\alpha + \frac{\beta}{4} & ; s_z = -1 \end{cases}$$

$$\Rightarrow \text{maximum gap} = \alpha + \frac{\beta}{4} - \left( -\frac{3\beta}{4} \right) = \alpha + \beta$$

53.(1)  $L_+ = L_x + iL_y$

$$L_- = L_x - iL_y$$

$$L_+L_- = L_x^2 + L_y^2 - L_z^2$$

$$\langle \Psi | L_+L_- | \Psi \rangle = \langle \Psi | L^2 - L_z^2 | \Psi \rangle$$

$$= \langle \Psi | L^2 | \Psi \rangle - \langle \Psi | L_z^2 | \Psi \rangle$$

$$= \hbar^2 \ell(\ell+1) - \hbar^2 \ell^2$$

$$\langle L_+L_- \rangle =$$

54.(4) Let  $C_1|1\rangle + C_2|2\rangle$  be an eigenket

Therefore  $H(C_1|1\rangle + C_2|2\rangle) = \lambda(|1\rangle + C_2|2\rangle)$

$$aC_1(|1\rangle + |2\rangle) + aC_2(-|2\rangle + |1\rangle) = \lambda(C_1|1\rangle + C_2|2\rangle)$$

equating coefficients of  $|1\rangle$  on both sides for  $|2\rangle$

Separately

$$aC_1 + aC_2 = \lambda C_1$$

$$aC_1 - aC_2 = \lambda C_1$$

The system of equation in  $C_1$  and  $C_2$  has a non-trivial solution

$$\begin{vmatrix} a - \lambda & a \\ a & -a - \lambda \end{vmatrix} = 0$$

$$-(a - \lambda)(a + \lambda) - a^2 = 0$$

$$\lambda = \pm\sqrt{2} a$$

The energy eigenvalues are  $\pm\sqrt{2} a$

55.(1)  $V_{in} = V_{out}$  at  $r=R$

$$\epsilon \frac{\partial V_{in}}{\partial r} = \epsilon_0 \frac{\partial V_{out}}{\partial r} \quad r = R$$

$$V_{out} \rightarrow -E_0 r \cos \theta \quad \text{for } r \gg R$$

$$V_{in}(r, \theta) = \sum A_\ell r^\ell P_\ell(\cos \theta)$$

$$V_{out}(r, \theta) = E_0 r \cos \theta + \sum \frac{B_\ell}{r^{\ell+1}} P_\ell(\cos \theta)$$

at the boundary

$$\sum_{\ell=0}^{\infty} A_\ell r^\ell P_\ell(\cos \theta) = -E_0 R \cos \theta + \sum \frac{B_\ell}{R^{\ell+1}} P_\ell \cos \theta$$

$$A_\ell R^\ell = \frac{B_\ell}{R^{\ell+1}}, \quad \text{for } \ell \neq 1$$

$$A_\ell R = -E_0 R + \frac{B_\ell}{R^2}$$

$$E_r \ell A_\ell R^{\ell-1} = -\frac{(\ell+1)}{R^{\ell+1}} \quad \text{for } \ell \neq 1$$

$$E_r A_\ell = -E_0 - \frac{2B_\ell}{R^3}$$

$$A_\ell = B_\ell = 0 \text{ for } \ell \neq 1$$

$$A_1 = \frac{-3}{\epsilon_r + 2} E_0 \quad B_1 = \frac{\epsilon_r - 1}{\epsilon_r + 2} R^3 E_0$$

$$v_{in}(r, \theta) = \frac{-3E_0}{\epsilon_r + 2} r \cos \theta = -\frac{3E_0}{\epsilon_r + 2} Z$$

$$E = \frac{3}{\epsilon_r + 2} E_0$$

VPM CLASSES is India's No. 1 Institute in CSIR UGC NET



**BASUDEV ROY**  
**AIR 1**  
**PHYSICS**  
**CSIR UGC NET**



**LINI K MATHEW**  
**AIR 5**  
**CHEMISTRY**  
**CSIR UGC NET**



**SUNIL BHEL**  
**AIR 5**  
**MATHEMATICS**  
**CSIR UGC NET**



**RINI VARGHESE**  
**AIR 8**  
**PHYSICS**  
**CSIR UGC NET**



**M. VENU GOPAL**  
**AIR 8**  
**MATHEMATICS**  
**CSIR UGC NET**



**JINIA SIKDAR**  
**AIR 9**  
**EARTH SCIENCE**  
**CSIR UGC NET**

## Testimonials

“VPM CLASSES study material was the backbone of my exam preparation.”

Name : BASUDEV ROY,  
Ranks : **AIR 1** - CSIR UGC NET (DEC-2010) PHYSICS,  
**AIR 10** - GATE 2011 PHYSICS



*Basudev Roy*

## TESTIMONIALS

“ I thank VPM CLASSES for the Good Quality Correspondence Course, as it helped me to qualify for CSIR UGC NET in Chemistry (Dec 2015) ”

NAME : MANDIRA CHATTERJEE

RANK : **AIR 4**

CSIR UGC NET DEC 2015 (CHEMISTRY)



*Mandira Chatterjee*

SCIENCE | ENGINEERING | COMMERCE | ARTS

IIT JAM, CSIR NET, GATE, UGC NET, SLET, TIFR, NIMCET, JEST, BHU, JNU, ISM etc.

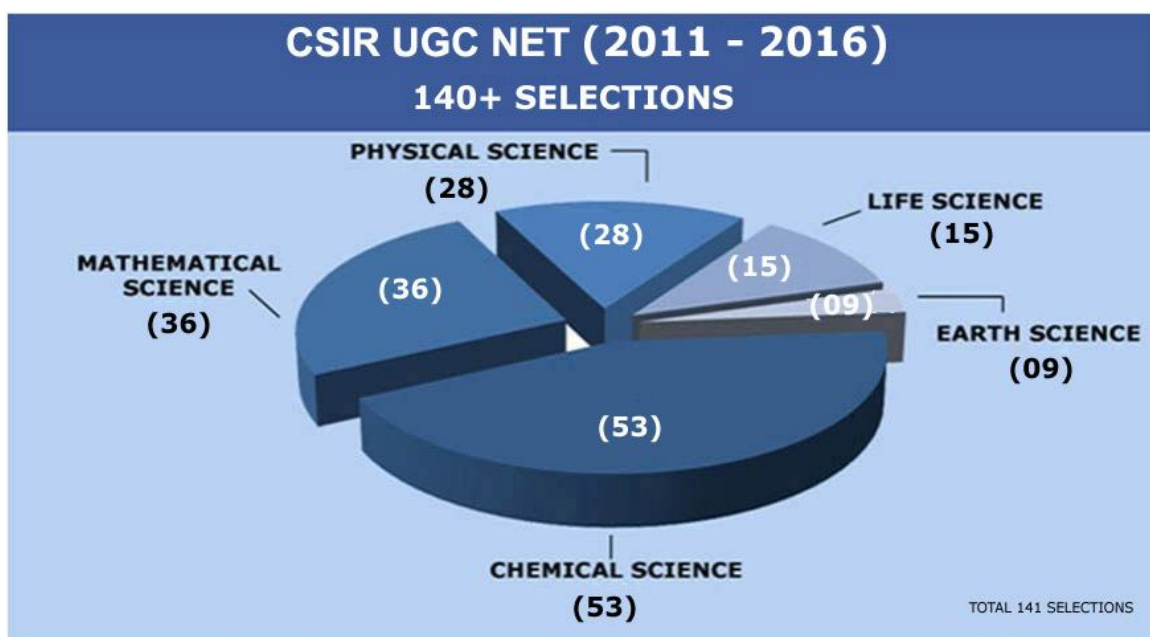

## VPM CLASSES CSIR UGC NET RESULTS 141 SELECTIONS

(\*including 32 ranks in june 2016 selections)



Anirban Bandyopadhyay  
Mathematical  
Science  
AIR-11



Anirban Sarka  
Physical Science  
AIR-18



Debasis Haldar  
Mathematical  
Science  
AIR-20

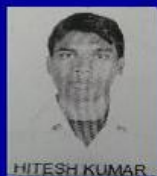

Hitesh Kuma  
Life Science  
AIR-30



Pranabendu Das  
Chemical  
Science  
AIR-31



Shreya Mukherjee  
Earth Science  
AIR-74

**32** selections in CSIR UGC NET JUNE 2016

<b>Address (Head Office)</b>	:-	VPM Classes, No. 8, Radha Nikunj – B Yojna, Opp. Iskcon Temple, Muhana Mandi Road, Near Mansarovar, Jaipur (Rajasthan), Pin Code - 302020
<b>Mobile No</b>	:-	9001297111 / 9829619614
<b>Toll Free</b>	:-	1800-2000-092
<b>What's app</b>	:-	9001894070 / 9001894076
<b>Email</b>	:-	info@vpmclasses.com , vpmclasses@yahoo.com
<b>Website</b>	:-	<a href="http://www.vpmclasses.com">http://www.vpmclasses.com</a>
<b>Online Student Portal</b>	:-	<a href="http://examprep.vpmclasses.com">http://examprep.vpmclasses.com</a>
<b>Online Store</b>	:-	<a href="http://store.vpmclasses.com">http://store.vpmclasses.com</a>
<b>Online Test Portal</b>	:-	<a href="http://onlinetest.vpmclasses.com">http://onlinetest.vpmclasses.com</a>
<b>Facebook</b>	:-	<a href="https://www.facebook.com/VpmClasses">https://www.facebook.com/VpmClasses</a>
<b>Twitter</b>	:-	<a href="https://twitter.com/vpmclasses">https://twitter.com/vpmclasses</a>
<b>LinkedIn</b>	:-	<a href="https://in.linkedin.com/in/vpmclasses">https://in.linkedin.com/in/vpmclasses</a>
<b>YouTube</b>	:-	<a href="https://www.youtube.com/VpmClasses">https://www.youtube.com/VpmClasses</a>
<b>APP</b>	:-	<a href="https://play.google.com/store/apps/details?id=com.mylogics.ots&amp;hl=en">https://play.google.com/store/apps/details?id=com.mylogics.ots&amp;hl=en</a>
<b>Follow us on</b>	:-	 / vpmclasses

